

Project: _____ Location: _____ Item #: _____ Quantity: _____

Short Specification

Griddle shall be an AccuTemp Compact Drop-In Model. 14" x 18" 208V modular drop-in electric heated unit, with hermetically- sealed vacuum chamber that produces steam to heat the 8-gauge stainless steel griddle plate. Efficient steam heat transfer provides 200–400°F (93–204°C) operating temperature range and uniform griddle surface temperatures of ±3°F (±1°C). Unit features all stainless steel construction and incorporates a new “drawn” manufacturing process that provides a generous full perimeter radius and aesthetically pleasing cooking surface recessed ¼” below the cabinet or table top mounting surface. This unit is available with an optional full width 3” by 1” deep grease trough module, with drop to an enclosed grease drawer. A solid-state thermostat controls the operating temperatures and never requires calibration.

Construction Features

- All stainless griddle module insulated and sealed for easy installation in new or existing cabinet or work station
- Sealed control panel provided for cabinet front mounting

Performance Features

- Hermetically-sealed steam/vacuum chamber mounted to and below griddle cooking surface
- 5-kW power input, with long-life low watt density heating elements mounted inside vacuum chamber and immersed in chemically pure water. (Water never needs replacement)
- Steam transfers heat evenly to cooking surface with only ±3°F (±1°C) in temperature variation
- Rapid surface temperature recovery (10 seconds or less) allows turning product to same spot when grilling
- Smooth cold-rolled stainless steel griddle surface speeds and simplifies cleaning
- ¼” recessed cook surface reduces splatter and cleanup of surrounding work surface

Standard Control Features

- Modular sealed control panel reduces grease infiltration and chance of flare-ups
- Power-On switch & indicator light
- Heating indicator light
- 200–400°F (93–204°C) solid state thermostat
- Easy front service access to all controls

Cooking Capacity & Applications

- Pancakes, Eggs, Sausage, French Toast
- Burgers, Grilled Onions, Toasted Buns
- Grilled Cheese, Monte Cristo & Ruben Sandwiches
- Fried Potatoes, Fish, Chicken Breasts, Sandwich Steaks, Liver and MORE

Environmental Approvals & Programs

- Griddle to be U.L. Sanitation to NSF
- Griddle to be U.L. Listed

Other Approvals



Installation Requirements

- 208/1 Power Source
- 208/3 Power Source
(See other side for AMP requirements.)
- Easy inter-module connection, with two cables provided
- Single main power connection required



EGD-21 Compact Drop-In Model
Cook Top & Control Modules Shown



EGD-21 Compact Drop-In Model
Control Module Shown



EGD-21 Compact Drop-In Model
Cook Top's available

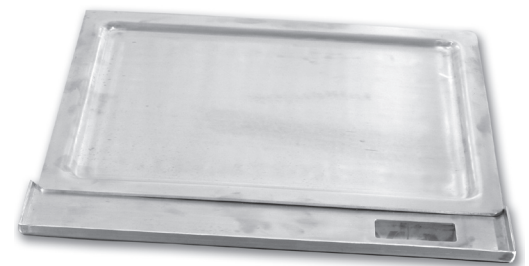

MM5216-1405



ACCU-STEAM™ COMPACT DROP-IN GRIDDLE
Electric/Steam-Heated, Drop-In Griddle

EG Series Griddle Specifications		
Model	EGD-21	EGD-21
kW Input	5.0	5.0
AMP	24.0	13.89
Phase	1	3
Unit Width	20.51"	20.51"
Cooking Width	17.66"	17.66"
Cooking Depth	14.16"	14.16"
Effective Cooking Area	250 sq in.	250 sq. in

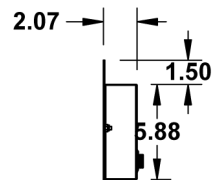
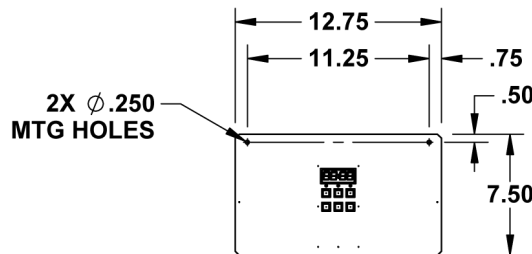
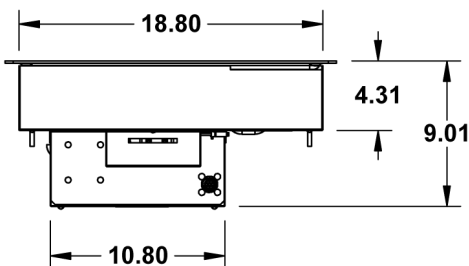
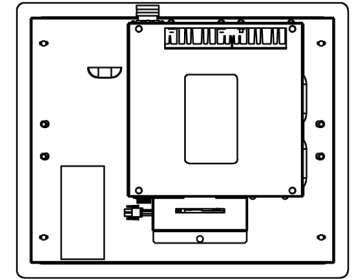
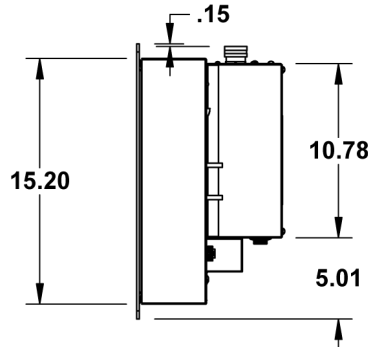
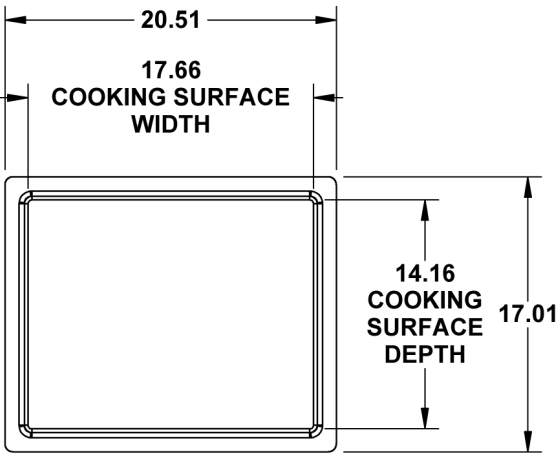
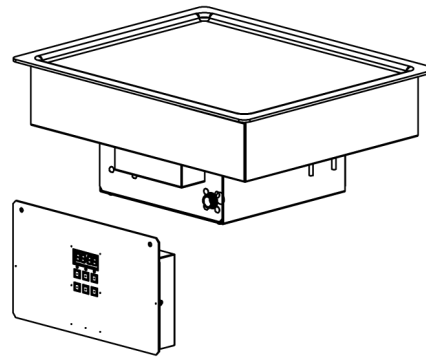
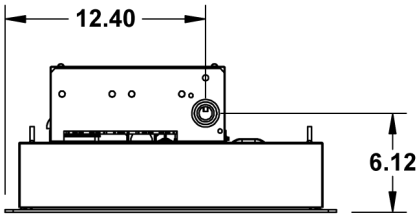

MM5216-1405